

FUZZY ADAPTATION IN A STATE SPACE CONTROLLER APPLIED FOR A TWO-MASS SYSTEM*

MATEUSZ ŻYCHLEWICZ, MARCIN KAMIŃSKI

Wrocław University of Science and Technology,
Wybrzeże Wyspiańskiego 27, 50-370 Wrocław, Poland,
e-mail addresses: mateusz.zychlewicz@pwr.edu.pl; marcin.kaminski@pwr.edu.pl

Abstract: Application of a state space controller for two-mass system has been examined. However, the classical version of the controller was modified in order to improve properties of the whole system. For this purpose fuzzy model was implemented as an adaptation element for the parameters. The theoretical description of the control structure, numerical tests and experimental results (using dSPACE1103 card) have been presented.

Keywords: *fuzzy gain scheduling, state space controller, gains adaptation, two-mass drive*

1. INTRODUCTION

In the control theory, adaptive models are often and widely applied. Numerous authors present advantages of such structures, especially in applications for uncertain objects, in the case of problems with complete and precise identification of parameters, changes of the objects during work and other special disturbances of the plant. Those models are used in control systems as controllers, observers or compensators [1–4]. Recent works related to adaptive control can be divided into two groups: First of them concerns hardware applications of known algorithms [5] and the second presents theoretical considerations [6].

Adaptive control algorithms applied for real plants are calculated using popular programmable devices. The criteria of selection of specific hardware platform depend on the type of applied adaptive control systems and frequency of calculation. The most popular seems to be implementation in digital signal processors, particularly for electrical drives [7–9]. In some cases the main model of the controller can perform parallel computation. Moreover, in general we can divide to parallel paths in adaptive processing: related to main path of controller and second for adaptation law. Those considerations can lead to implementation of adaptation control structures in FPGA [10, 11]. Nowadays, trend presenting application of control algorithms in low-cost chips, can be

*Manuscript received: March 24, 2017; accepted: June 28, 2017.

observed. It is important advantage especially for industrial applications. Thus, solution with 8-bit microcontrollers are also found [12].

Adaptive control theory presents different strategies of structures used for uncertain plants (for instance, direct adaptive control and indirect adaptive control) [13]. Models of the adaptive controllers can be based on classical PI/PID topologies [14], in other works neural and fuzzy models are used [15, 16]. The problems during design process and implementation of the code for calculation of many tested control methods can be caused by adaptation based on derivative (in some cases second order) of the cost function with respect to variables of the system. It can lead to complicated calculations and difficult hardware application. Other difficulties are related to identification of the object and complicated mathematical calculations used in design process.

The present paper presents adaptive control structure applied for a two-mass system. This model corresponds to mechanical part of the electrical drive with elastic long shaft connecting motor and load [17]. Finite stiffness of the coupling can lead to formation of oscillations of signals. It depends also on relationship between the mechanical parameters of load and motor [18]. When this ratio is below one, there are more oscillations and overshoot are visible. However, it can be reduced using other techniques (comparing to classical PI/PID controllers) like a state space controller or advanced structures, including neural networks or fuzzy logic controllers. Overall precise and dynamic speed control can be achieved using complete vector of state variables. However in industrial applications, parameters of the plant are not always available or can be changeable during work of the system. It introduces additional problems for a precise control. The most important assumptions for the proposed system are simplicity of the main controller and design process of adaptation algorithm, improvement of a classical controller (better work under disturbed parameters of the drive). For those purposes, fuzzy gain scheduling (FGS) in a state space controller is applied.

Reports on knowledge-based systems in control systems are still increasing, however other significant (considering number of application and promising results) subgroup of applications should be highlighted – based on combination of classical controllers (or observers) with fuzzy and neural models [19–22]. One of the most problematic issues related to adaptive structures that are based on models from artificial intelligence theory is stability analysis. The most often some limitations to coefficients of adaptation law are introduced [23–25]. The considerations are done using the Lyapunov theory. Extended mathematical description and simulation presenting modification of PID controller has been proposed in [26]. The authors reviewed practical methods of stability proof. It is especially important in relation to application of fuzzy models, where one of the main assumptions is design based on set of rules and the mathematical model should be simplified. Such approach can make fuzzy adaptive controllers more attractive for industry. Next issue in application of fuzzy models is proper selection of constant parameters needed for calculation of the algorithm. It applies also to adaptive fuzzy models, coefficients used in adaptation law or scaling factors used for input/output signals

should be appointed during design process. Mathematical analysis is often complicated and those values are selected experimentally. Costa et al. [27] successfully applied the particle swarm optimization algorithm for selection of coefficients in a fuzzy gain scheduling controller. The parameters of the adaptive controller proposed in this paper were selected using also a metaheuristic algorithm – Grey wolf optimizer (GWO) which has been presented elsewhere [28]. In the paper, simple adaptation of state space controller, realized using a fuzzy model, has been proposed. Details of the control structure are presented in the following parts of paper.

The application of the adaptive state space controller optimized using the fuzzy model for a two-mass system has been presented. After introduction, the mathematical model of the plant and overall control structure have been described. Then, fuzzy gain adaptation of the state space controller has been presented with the description of simulations conducted (including comparison to a classical state space controller). For experimental verification, the whole control algorithm was implemented in the processor of a dSPACE card and initial laboratory tests were made.

2. MATHEMATICAL MODEL OF THE CONTROL STRUCTURE

Many mathematical models have been published that can describe physical phenomena occurring in two-mass systems. The most popular inertia-free-shaft two mass system model is used in this paper [8] due to its simplicity and correct results obtained in experimental verification. The state equation describing this part of the structure is as follows:

$$\frac{d}{dt} \begin{bmatrix} \omega_1(t) \\ \omega_2(t) \\ m_s(t) \end{bmatrix} = \begin{bmatrix} 0 & 0 & -\frac{1}{T_1} \\ 0 & 0 & \frac{1}{T_2} \\ \frac{1}{T_c} & -\frac{1}{T_c} & 0 \end{bmatrix} \begin{bmatrix} \omega_1(t) \\ \omega_2(t) \\ m_s(t) \end{bmatrix} + \begin{bmatrix} \frac{1}{T_1} & 0 \\ 0 & -\frac{1}{T_2} \\ 0 & 0 \end{bmatrix} \begin{bmatrix} m_e \\ m_L \end{bmatrix} \quad (1)$$

where: ω_1, ω_2 – motor and load speeds, m_e, m_s, m_L – electromagnetic, shaft and load torques, T_1, T_2 – mechanical time constants of motor and load, T_c – the stiffness constant. All values of state variables are normalised to per unit system.

Main transfer functions of a two-mass drive are:

$$G_p^{\omega_1}(s) = \frac{\omega_1}{m_e} = \frac{s^2 T_2 T_c + 1}{s^3 T_1 T_2 T_c + s(T_1 + T_2)} \quad (2)$$

$$G_p^{\omega_2} = \frac{\omega_2}{m_e} = \frac{1}{s^3 T_1 T_2 T_c + s(T_1 + T_2)} \quad (3)$$

Based on Eqs. (2), (3), the Bode plots were prepared, examples (for nominal parameters) are presented in Fig. 1.

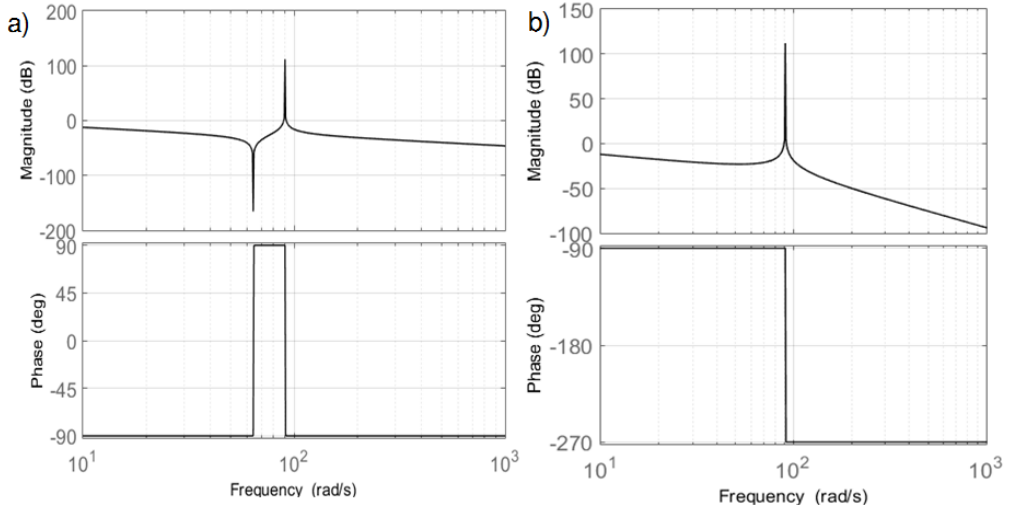

Fig. 1. Bode diagram of the open-loop two-mass system transfer functions

Equations describing resonant and anti-resonant frequencies of a drive are as follows:

$$\omega_{\text{res}} = \sqrt{\frac{T_1 + T_2}{T_1 T_2 T_c}} \quad (4)$$

$$\omega_{a \text{ res1}} = \sqrt{\frac{1}{T_1 T_2}} \quad (5)$$

$$\omega_{a \text{ res2}} = \sqrt{\frac{1}{T_1 T_c}} \quad (6)$$

Figure 1a shows the Bode plots of a main transfer function for motor speed (2). There are two specific points – resonant and anti-resonant frequency. Figure 1b is related to the transfer function (3). The resonant frequency of a drive can be characterized by Eq. (4) and the anti-resonant one by (Eqs. (5), (6)). It should be noticed that increasing load time constant can lead to lower values of both resonant and anti-resonant fre-

frequencies. On the other hand, higher values of this time constant can force lower frequencies calculated using Eqs. (4)–(6). The same tendency occurs in the presence of fluctuations of the stiffness time constant. Based on Fig. 1 and Eqs. (4)–(6), it appears that the above parameters influence operation of the plant.

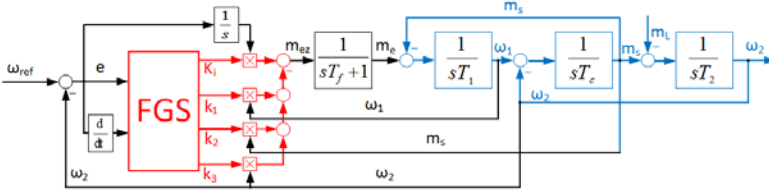

Fig. 2. Block diagram of the control structure

The block diagram of the controlled structure is presented in Fig. 2. In relation to real, industrial application, the phenomenon observed in a two-mass system can be found in an electrical drive with long elastic coupling between the motor and load. Thus, the overall control system is based on the cascade structure that contains internal torque control loop and external speed control loop. Starting from the left hand side, the system consists of a FGS block with four fuzzy systems to calculate coefficients for the state space controller. The control signal is shaped based on three state variables from the plant, additionally an integration element is also added to prevent a steady state error. The torque control loop is represented by the first order transfer function. This means that delay related to electromagnetic part of the drive after optimization is simplified to this form. T_f is initially set to 0 (influence of this simplification has been tested). It should be noted that, for higher power machines, this delay cannot be neglected but in these studies only low power machines are discussed.

The main part of the system presented in Fig. 2 is a speed controller. The solution is based on the structure of the state space controller, full state vector is used for calculation of the control signal:

$$m_{ez} = K_I \int (\omega_{ref} - \omega_2) dt - k_1 \omega_1 - k_2 m_s - k_3 \omega_2 \quad (7)$$

where K_I, k_1, k_2, k_3 are the gains of the controller.

The nominal values of the coefficients for the state space controller can be acquired by means of the analytical synthesis [18]. This method requires only easy calculations and allows also forcing wide range of dynamics, determined by properly set of the system poles.

$$K_I = \omega_r^4 T_1 T_2 T_c \quad (8)$$

$$k_1 = 4\xi \omega_r T_1 \quad (9)$$

$$k_2 = T_1 T_c \left(2\omega_r^2 + 4\xi^2 \omega_r^2 - \frac{1}{T_2 T_c} - \frac{1}{T_1 T_c} \right) \quad (10)$$

$$k_3 = \omega_r^2 k_1 T_2 T_c - k_1 \quad (11)$$

where: ω_r – the resonance pulsation, ξ – the damping coefficient.

3. FUZZY GAIN SCHEDULING STATE SPACE CONTROLLER

One of the major weakness of the state controller, if precise control is assumed, is the need of collecting information about exact model of the plant and precise identification of parameters. To overcome those disadvantages, modified state controller using the FGS method has been proposed. FGS is an approach in control theory that tends to use group of linear controllers (PI or PID). Each controller is suited for control at a certain operating point. One or more scheduling variables are used to determine exact operating point of a plant and resolve an optimal controller for this point [29]. Gain scheduling is a very common practice in many science application but it is difficult to find an application of fuzzy adaptation for a state space controller implemented in the speed control loop of an electrical drive with elastic connection.

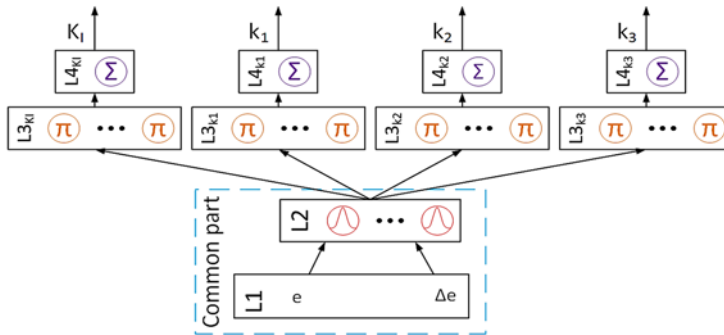

Fig. 3. Overall structure of the fuzzy system

In this paper, the FGS is used for on-line tuning of the classical controller. This method uses fuzzy models to set a current state of the system, instead of adaptation of the controller parameters according to laws based on the derivative of cost function. With respect to the fuzzy models, it consists of many controllers that are switched based on implemented rule sets and an appropriate arrangement of membership functions. The state space controller consists of four introduced fuzzy models working independently. During implementation of the code, to optimize the structure of the controller (for easier implementation in DSP and faster computation), fuzzification part is common for all

four fuzzy models. Each model calculates the gain of the speed controller, that is later multiplied with appropriate state variable as shown in Fig. 2.

The basic structure of the fuzzy model contains parallel calculations combined in subsequent layers. Fuzzy model applied for state space controller is presented in Fig. 3. It consists of 4 main layers:

- Layer 1 ($L1$) passes scaled inputs to the next layer. In this case, layer 1 corresponds to the error (e) and change of error (Δe) signals.
- Layer 2 ($L2$) fuzzifies inputs based on membership functions that are implemented.
- Layer 3 ($L3$) is applied to calculate the premises for all signals from previous layer. By applying T-norm (which is prod in this case) all inputs from the layer 2 are multiplied.
- Layer 4 ($L4$) is a final layer which calculates final value of the fuzzy system. All of the weights w_j are multiplied by corresponding nodes. Last part of the calculations in a fuzzy system deals with defuzzification, calculations are done using following equations [19]:

$$k = \frac{\sum_{j=1}^m w_j u_j}{\sum_{j=1}^m w_j} \tag{12}$$

where: u_j is the activation level of the j -th rule, w_j is a singleton value.

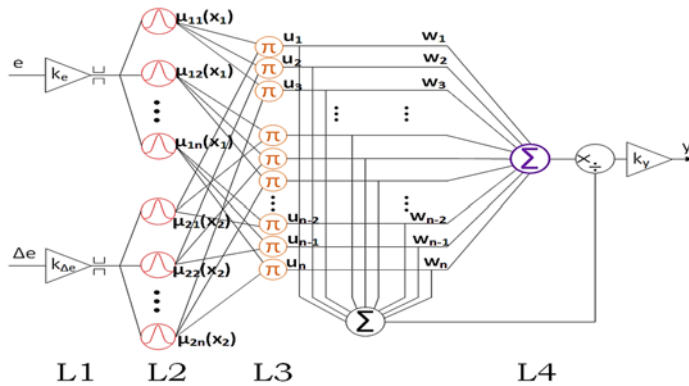

Fig. 4. General structure of fuzzy model used for on-line tuning of state space controller

To ensure proper work of the fuzzy system, knowledge about control process is required; it helps setting up all parameters of the fuzzy model like membership functions or rule base. If this prerequisite is not met, the designer has to check how the system is

working. Similar procedure was done in the case of the analyzed state space controller. Error and derivative of this signal were observed if a step response of the system was forced (additionally those of controller parameters were noticed).

It should be mentioned that every inputs to the system (Fig. 4), as well as output are scaled (coefficients $k_e, k_{\Delta e}, k_y$), additionally, input and output gains of each fuzzy model, singletons arrangement as well as rule sets were optimized (off-line) using metaheuristic algorithm – Grey wolf optimizer [28].

4. RESULTS OF SIMULATION

Control structure described in Section 3 was implemented in MATLAB/Simulink. Following parameters of the two-mass system were assumed: $T_1 = 0.203$ s, $T_2 = 0.203$ s and $T_c = 0.0012$ s. All tests were done for the reference speed equal to 25% of the nominal value, to show the behaviour of the system when there is no limitation of electromagnetic torque. The load torque is changed twice, to show how it affects state variables. Transients of the reference speed and load torque are presented in Fig. 5.

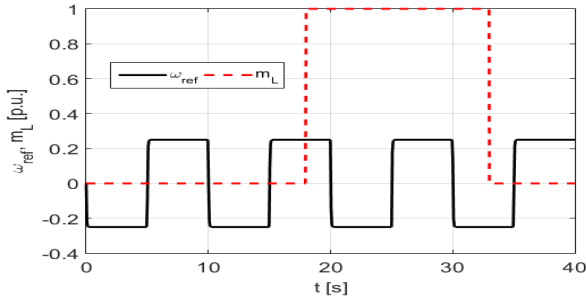

Fig. 5. Reference speed and load torque used in tests (simulations)

As can be seen in Fig. 6 (for better presentation of details, additional results – zoomed transients – are presented in Fig. 7), dynamics of the classical state controller is really high, there is no overshoots and reaction to load torque switching is fast. Transients obtained using both controllers, classical and adaptive, are similar. It is caused by the same initial parameters of a modified controller, as in the classical structure. It should be mentioned that all gains of the classical controller were calculated based on Eqs. (8)–(11). Tests, presented in Fig. 8, show the transient of state variables under changes of state variables during the work of the drive, mechanical time constant of load is changed in $t = 20$ s. After changing the load time constant (T_2), five times greater than the nominal one, overshoots and oscillations in transients of speeds are observed (Fig. 8a). Dynamics of the control structure with an adaptive state space controller is as

high as it is for nominal parameters of the drive. There is even less reaction to load torque after changing time constant due to use of fuzzy models. Higher values of electromagnetic torque is observed but it is normal when such change of parameter is introduced.

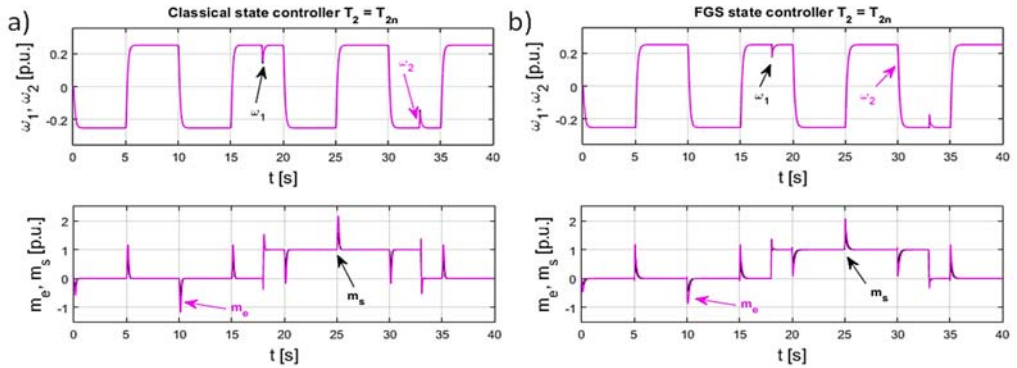

Fig. 6. Transients of state variables for structures with classical state space controller (a) and fuzzy state space controller (b) in the case of nominal parameters of the drive

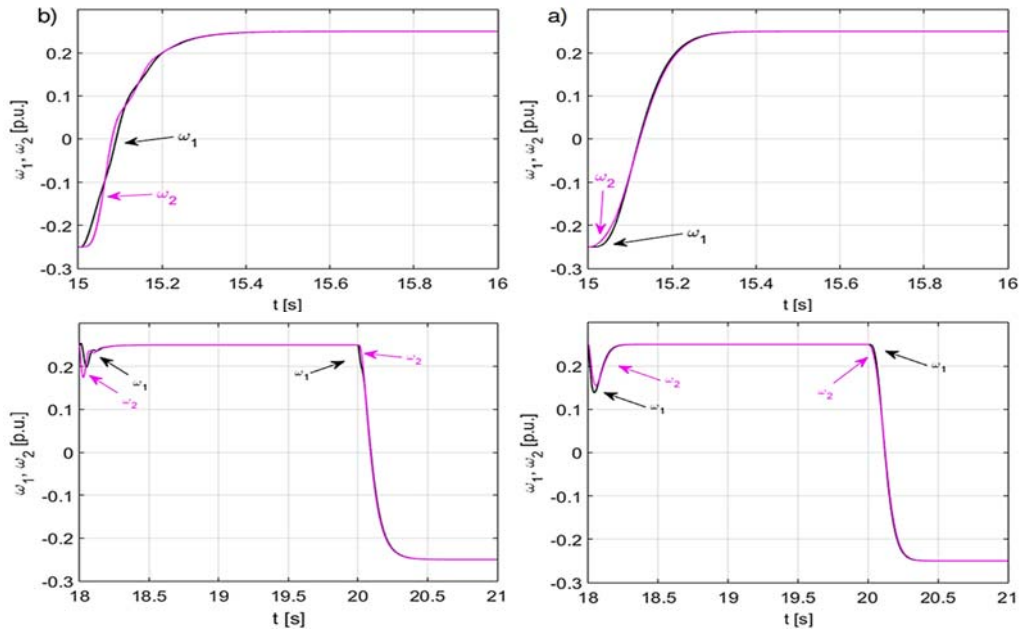

Fig. 7. Transients of state variables for structures with a classical state space controller (a) and a fuzzy state space controller (b) in the case of nominal parameters of the drive – zoom introduced for selected part of figures

Change of gains of the FGS state space controller is shown in Fig. 9. The controller is reacting to disturbances applied to the system. After changing the time constant (in 20 s of simulation, Fig. 9), all gains have increased values. The operating point is switched and the speed is still close to the reference trajectory. The trends of changes of parameters in adaptive state space controllers seem to be interesting. Table 1 presents gains for both controllers. Second column shows values for gains calculated for the nominal values of parameters using Eqs. (8)–(11). Then, the recalculations for a changed time constant of the load were done (second column). Third and fourth columns of Table 1 present values of parameters selected using fuzzy models. The coefficients were measured before changes of T_2 and after that disturbance. Generally, it leads to conclusion that values of gains in both controllers are close and the way of changes is similar, however proposed adaptation introduces recalculation automatically.

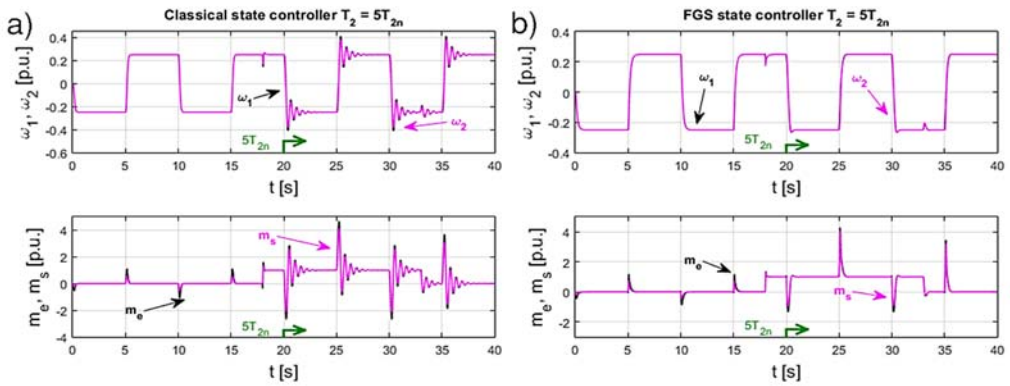

Fig. 8. Transients of state variables for structures with classical state space controller (a) and fuzzy state space controller (b) – changed parameter (T_2) of the plant

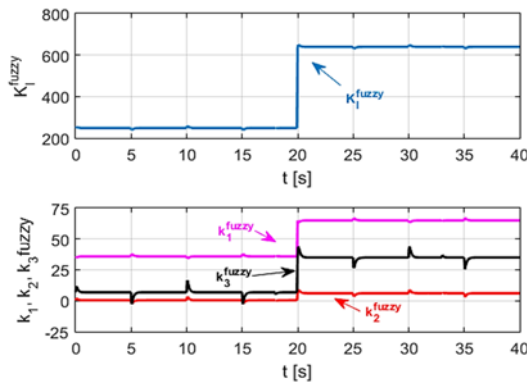

Fig. 9. Change of parameters in FGS state space controller

Table 1. Comparison of gains for both controllers

Parameter	Pole distribution		FGS	
	$T_2 = T_{2n}$	$T_2 = 5T_{2n}$	$T_2 = T_{2n}$	$T_2 = 5T_{2n}$
K_I	126.59	632.97	248.25	639.54
k_1	32.48	32.48	35.90	65.01
k_2	0.39	1.14	0.39	6.07
k_3	-19.82	30.82	6.83	34.98

Next results of studies present correct work of the control system if T_2 is set to $T_2 = 0.5T_{2n}$. The results are similar for both controllers, however faster reaction of the adaptive controller can be seen during switches of the load (Fig. 10).

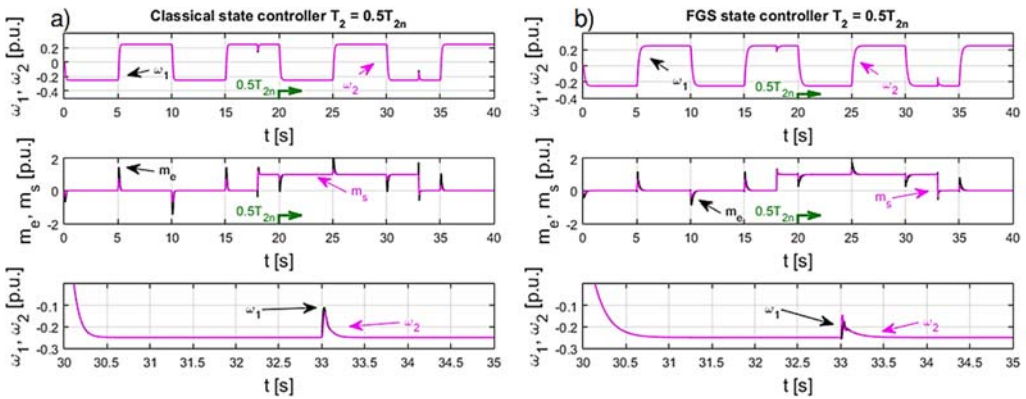

Fig. 10. Transients of state variables for structures with classical state space controller (a) and fuzzy state space controller (b); changed parameter (T_2) of the plant

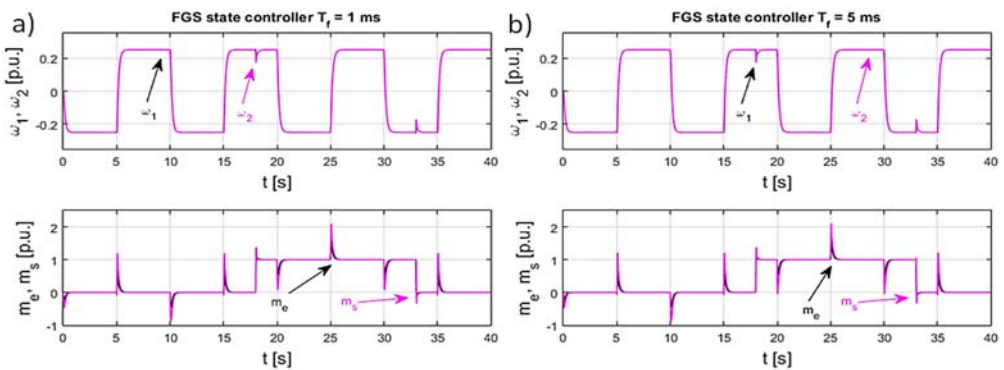

Fig. 11. Transients of state variables for fuzzy state space controller – influence of different time of calculations in torque shaping loop

The adaptive controller was applied in a speed control loop of an electrical drive. Overall, such structure contains an additional internal torque control loop. This part of the drive introduces additional disturbances (delays for signal processing, measurement noises) for a speed controller. Moreover, this control loop was not taken into account during calculation of Eqs. (8)–(11). However it is obvious that in a real drive time the constant T_f is not equal zero. The more interesting are tests of the fuzzy space controller under increase of this value. The results are presented in Fig. 11. The delays caused by the electromagnetic loop are not affecting the drive. Transients are similar to those in Fig. 6b. Noteworthy is fact that the only minor differences are found in transients of torques (18 s of simulation).

To compare both structures, a performance index – the integral of time multiply square error (ITSE) – was introduced. The several values of errors were obtained using the following formula:

$$ITSE = \int_0^{t_{sim}} te^2(t)dt \text{ [p.u.]} \quad (13)$$

where: t_{sim} – total simulation time, e – error defined as a difference between the load motor speed and reference speed.

Table 2 presents the performance indexes for both control structures: with the adaptive state space controller and containing a fixed state space controller. It can be clearly seen that the errors by this method were smaller than in the classical control structure. Change in its value is relatively small in comparison to the state space controller – one exception is when T_2 is set to $5T_2$.

Table 2. Values of the *ITSE* index
for classical and adaptive state space controllers

Time constant	State space controller	FGS state space controller
$T_2 = T_{2n}$	3.095	2.377
$T_2 = 2T_{2n}$	3.398	2.523
$T_2 = 5T_{2n}$	5.015	3.011
$T_2 = 0.5T_{2n}$	2.978	2.314
$T_c = 2T_{cn}$	3.404	2.392
$T_c = 0.5T_{cn}$	3.011	2.375
$T_f = 0.001$	3.096	2.377
$T_f = 0.005$	3.168	2.378

5. EXPERIMENTAL RESULTS

Laboratory setup (Fig. 12) consisted of two DC motors with the nominal power equal 500 W. Machines were connected using a long shaft made from steel. To change

the time constant of the load, the motor flywheel was changed to set proper (other than nominal) time constant of the motor or load. Motors were fed by a power converter, current measurement was done using LEM sensors. Incremental encoders were implemented to measure the speed of the motors. The whole drive was managed using dSPACE1103, all devices were connected to this card through a control panel. The code of the algorithm was implemented in dSPACE directly using the Matlab and Simulink environment.

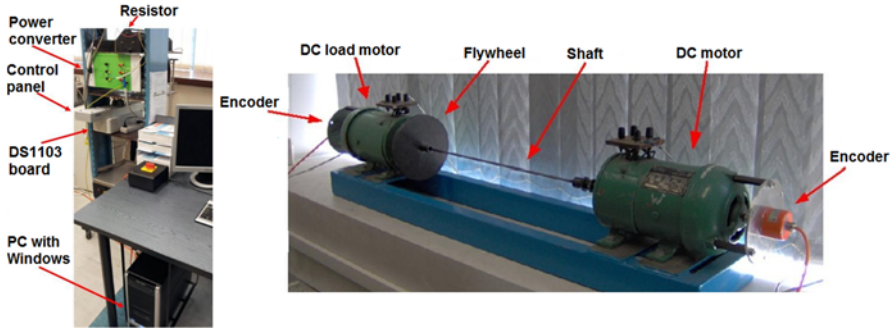

Fig. 12. Laboratory DC drive stand

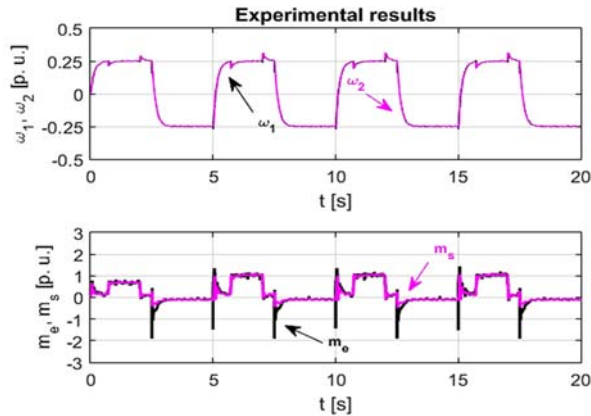

Fig. 13. Transients of state variables for modified (FGS state space) controller

The results of the first experiment present correct work of the speed controller. The reference speed is equal to 25% of the nominal value, cyclic reversions with frequency of 0.2 Hz are performed. During steady states the load is switched. Tests have been done for 20 s. The obtained transients are presented in Fig. 13. The controller is able achieve no overshoots in speed transients, as well as fast and precise response to the reference signal.

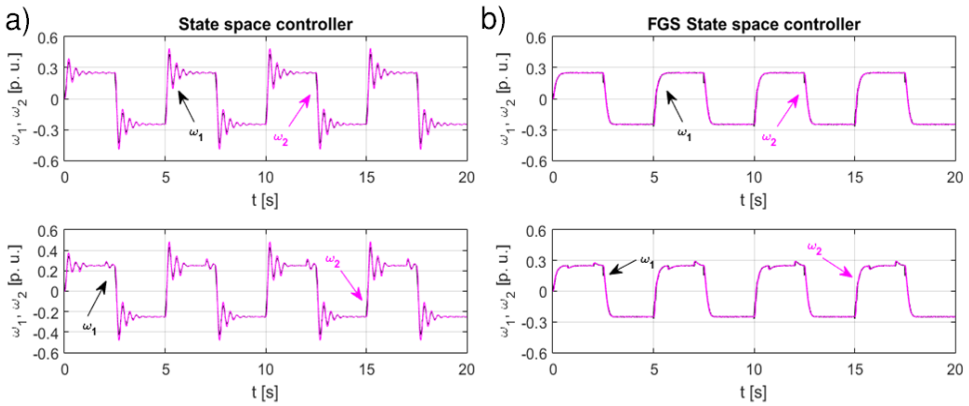

Fig. 14. Speed transients for compared controllers - performed for $T_2=5T_{2n}$

In Figure 14, comparison between the classical state space controller and the modified model used in a speed control loop is shown (those transients are related to increased time constant T_2 , modified in real stand using additional flywheel). Gains of the classical controller depend highly on the correct identification of the time constants of the plant, so any disturbances of T_2 lead to high overshoots of the motor speed and load speed (Fig. 14a). Gains of the FGS state space controller adapted during changes of plant parameters and oscillations are successfully damped (Fig. 14b). It should be mentioned that the tests were done twice, for no load case and after activation of the second motor. Both tests present high quality of control obtained using adaptive controller. It should be also mentioned that results (especially for a modified controller) are similar to simulation, that can enable an application of proposed controller in real drives.

6. CONCLUSIONS

A FGS state space controller applied to a drive with an elastic joint has been presented. The controller used fuzzy models to compute gains for feedback connections. The control structure has been successfully implemented in the Matlab/Simulink and tested in simulations and experiments leading to the following conclusions.

- A state space controller with fuzzy adaptation of gains can be used in the speed control loop of an electrical drive with elastic joint.
- The results show that the drive is working with the same dynamics as a classical structure and effective damping of state variables oscillations (for nominal parameters of the two-mass system).
- Additional disturbances like changes of parameters do not affect state variables of the system, fuzzy adaptation works correctly.

- Fuzzy adaptation algorithm does not use mathematical model or parameters of the object.
- One of the main goals of the work was improvement of properties of a classical state space controller applied for a two-mass system. For the numerical assessment of quality of results, the performance error was introduced. Calculation of this parameter for various tests of the drive, including changes of time constants, gives possibility of comparison between both controllers implemented in speed control loop of electrical drive. Firstly, control structures were rated for nominal parameters of the drive. Error for classical controller was equal 3.095, after introduction of adaptation it decreases to 2.377. In next cases, after changes of the nominal parameters of the plant, speed control errors were also reduced using a modified state space controller. The highest value of the *ITSE* index occurs when the mechanical time constant of the load was increased to $5T_{2n} - 3.011$ (for the FGS state space controller). The fluctuations of the error values for the adaptive state space controller are not so large as in the case of the classical controller. All the results show better indexes for the modified state space controller in comparison with the classical one.
- Selection of the reference model is not needed (embarrassing in the case of implementation of fuzzy or neural adaptive controllers).
- The developed control algorithm can be used in industrial applications because of the simplicity and effectiveness. Its correct work was verified in experiments.

REFERENCES

- [1] WANG F., DAVARI S.A., CHEN Z., ZHANG Z., KHABURI D.A., RODRIGUEZ J., KENNEL R., *Finite control set model predictive torque control of induction machine with a robust adaptive observer*, IEEE Trans. Ind. Electron., 2017, 64(4), 2631–2641.
- [2] WU T.-Y., LAI C.-Y., CHEN S., *An adaptive neural network compensator for decoupling of dynamic effects of a macro-mini manipulator*, IEEE International Conference on Advanced Intelligent Mechatronics (AIM), 2015, 1427–1432.
- [3] CHEN T.-C., SHEU, T.-T., *Model reference neural network controller for induction motor speed control*, IEEE Trans. Energy Conv, 2002, 17(2), 157–163.
- [4] HUREZEANU A., NICOLA M., SACERDOTIANU D., *Sensorless control using the model reference adaptive control estimator in electric drives with high dynamic*, International Conference on Applied and Theoretical Electricity (ICATE), Romania, 2016.
- [5] YING-SHIEH K., MING-SHYAN W., CHUNG-CHUN H., *Digital Hardware Implementation of Adaptive Fuzzy Controller for AC Motor Drive*, Annual Conference of the IEEE Industrial Electronics Society (IECON), Taiwan, 2007, 1208–1213.
- [6] KOZAK S., *State-of-the-art in control engineering*, J. Electr. Syst. Inf. Technol., 2014, 1(1), 1–9.
- [7] SZABAT K., *Direct and indirect adaptive control of a two-mass drive system. A comparison*, Proc. IEEE International Symposium on Industrial Electronics, Cambridge, UK, 2008, 564–569.
- [8] CHANG I.-P., HUNG Y.-C., HWANG J.-C., LIN F.-J., TSAI M.-T., *Digital signal processor-based probabilistic fuzzy neural network control of in-wheel motor drive for light electric vehicle*, IET Electric Power Applications, 2012, 6(2), 47–61.
- [9] DWIVEDI S., SRIVASTAVA S.P., TAJNE S.K., *Comparative Performance Analysis of Vector Controlled Induction Motor Drive for Neural Controller and DSP Implemented PI Controller*, International Conference on Communication Systems and Network Technologies (CSNT), India, 2012, 274–281.

- [10] CAO J., NGUANG S.K., SALCIC Z., *A Floating-Point FPGA-Based Self-Tuning Regulator*, IEEE Trans. Ind. Electron., 2006, 53(2), 693–704.
- [11] KAMINSKI M., ORLOWSKA-KOWALSKA T., *FPGA implementation of ADALINE-based speed controller in a two-mass system*, IEEE Trans. Ind. Electr., 2013, 9(3), 1301–1311.
- [12] DOSTALEK P., DOLINAY Y., VASEK V., PEKAR L., *Self-tuning digital PID controller implemented on 8-bit freescale microcontroller*, Int. J. Math. Models Meth. Appl. Sci., 2010, 4(4), 274–281.
- [13] LANDAU I.D., LOZANO R., M'SAAD M., KARIMI A., *Adaptive Control Algorithms, Analysis and Applications*, Springer-Verlag, London 2011.
- [14] CHAIYATHAM T., NGAMROO I., *Improvement of power system transient stability by pv farm with fuzzy gain scheduling of PID controller*, IEEE Syst. J., 2014, 99, 1–8.
- [15] LIN F.-J., WAI R.-J., *Adaptive Fuzzy-Neural-Network Control for Induction Spindle Motor Drive*, IEEE Trans. En. Conv., 2002, 17(4), 507–513.
- [16] SEDHURAMAN K., HIMAVATHI S., MUTHURAMALINGAM A., *Comparison of learning algorithms for neural network based speed estimator in sensorless induction motor drives*, IEEE International Conference on Advances In Engineering, Science and Management (ICAESM), India, 2012, 196–202.
- [17] SZABAT K., ORLOWSKA-KOWALSKA T., *Vibration suppression in a two-mass drive system using PI speed controller and additional feedbacks. Comparative study*, IEEE Trans. Ind. Electr., 2007, 54(2), 1193–1206.
- [18] ZHANG G., FURSHO J., *Speed control of two-inertia system by PI/PID control*, IEEE Trans. Ind. Electr., 2000, 47(3), 603–609.
- [19] SZABAT K., TRAN-VAN T., KAMINSKI M., *A modified fuzzy Luenberger observer for a two-mass drive system*, IEEE Trans. Ind. Informatics, 2015, 11(2), 531–539.
- [20] SYED F.U., KUANG M.L., SMITH M., OKUBO S., YING H., *Fuzzy gain-scheduling proportional-integral control for improving engine power and speed behavior in a hybrid electric vehicle*, IEEE Trans. Vehicular Techn., 2009, 58(1), 69–84.
- [21] KANTHAPHAYAO Y., CHUNGKAG V., *Current-sharing bus and fuzzy gain scheduling of proportional-integral controller to control a parallel-connected AC/DC converter*, IET Power Electr., 2014, 7(10), 2525–2532.
- [22] POPA D.D., CRACIUNESCU A., KREINDLER L., *A PI-fuzzy controller designated for industrial motor control applications*, IEEE International Symposium on Industrial Electronics (ISIE), 2008, 949–954.
- [23] QIAO J., HAN H.-G., RUAN X., *Research on fuzzy neural network based on lyapunov stability theory and its application*, Proceedings of the IEEE International Conference on Networking, Sensing and Control, ICNSC, China, 2008.
- [24] ATIG A., DRUAUX F., LEFEBVRE D., ABDERRAHIM K., ABDENNOUR R.B., *On Lyapunov stability of nonlinear adaptive control based on Neural Networks Emulator and Controller*, 20th Mediterranean Conference on Control & Automation (MED), Spain, 2012, 272–277.
- [25] ZERAATKAR E., KARIMAGHAEI P., NOROOZI N., *A quasi-PID backpropagation algorithm based on Lyapunov stability theory for neural network*, 19th Iranian Conference on Electrical Engineering (ICEE), 2011.
- [26] ZHAO Z.-Y., TOMIZUKA M., ISAKA S., *Fuzzy gain scheduling of PID controllers*, IEEE Trans. Syst., Man, Cybern., 1993, 23(5), 1392–1398
- [27] COSTA E.B., SERRA G.L.O., *Fuzzy gain scheduling design based on multiobjective particle swarm optimization*, Latin America Congress on Computational Intelligence, 2015.
- [28] MIRJALILIA S., MIRJALILIB S.M., LEWIS A., *Grey Wolf Optimizer*, Advances in Engineering Software, 69, 2014, 46–61.
- [29] LEITH D.J., LEITHEAD W.E., *Survey of gain-scheduling analysis and design*, Int. J. Control, 2000, 73(11), 1001–1025.