

FUZZY ADAPTIVE CONTROL OF NONLINEAR TWO-MASS SYSTEM*

KAROL WRÓBEL

Department of Electrical Machines, Drives and Measurements,
Wrocław University of Science and Technology, Wrocław, Poland,
e-mail: karol.wrobel@pwr.edu.pl

Abstract: In the paper, an adaptive control MRAS-based structure for nonlinear two-mass system is proposed. The performance of the control structure is supported by additional compensator. After short introduction a mathematical model of the drive system is presented. In the plant, the additional nonlinearities such as friction and mechanical hysteresis are considered. Then the structure of the fuzzy system is shown. Contrary to the majority of papers the controller considered is based on the II type fuzzy sets. Then the simulation tests showing performance of the proposed structure are presented. The drive is tested at different operation points, including low-speed region where friction plays dominant role. A comparison of classical PI controller with antiwindup and the proposed structure is presented. Then laboratory set-up with DC motor is described briefly. Experimental results are included in the paper. It is shown that the torsional vibrations of two-mass system are damped effectively. The impact of the existing delays of system is discussed. A summary is given at the end of the paper.

Keywords: *fuzzy control, adaptive control, nonlinear two-mass system, compensation of friction*

1. INTRODUCTION

Fuzzy control possesses several advantages such as robustness, model free design and rule based algorithm. Those features decide of the popularity of this methodology in science and industry. The classical fuzzy controllers are designed based on knowledge of process experts. Despite several advantages, this methodology can cause several problems such as numerical instability, empty control regions (where control laws are not defined), contrary rules, etc. More systematic design procedure is used in so called fuzzy PID controllers. The other types of control is TSK fuzzy system. However, robustness of those approaches is also limited. Therefore, other solutions are looked for.

* Manuscript received: June 3, 2016; accepted: September 12, 2016.

In the last decades the adaptive fuzzy control becomes more and more popular. There are a lot of industrial examples of such applications in different areas including electrical drive control. One of the most popular concepts in adaptive system is MRAS (Model Reference Adaptive System) based structure. It allows desired dynamics of the plant to be selected. Based on the Lyapunov theory the adaptation laws can be derived and stability of the whole system can be proven. In [1], an adaptive control structure for servo-motor is proposed. In order to increase robustness of the system a controller based on the sliding-mode theory is proposed. A control structure for industrial robot is investigated in [2]. The authors report very good dynamic properties of such a system. The fuzzy controller with additional inner recurrences is demonstrated in [3]. The impact of different recurrences to the drive performance is analysed. The application of Petri layer to the neuro-fuzzy structure is proposed in [4]. This approach is further developed in [5], where more modifications of neuro-fuzzy structure are investigated. The improvements of different control indexes and at the same time reduction of numerical complexity of the whole algorithm are reported.

In the above-mentioned papers, different modifications of fuzzy system improving the quality of control are reported. Still, requirements defined for control system are continuously increasing. In recent years, applications of II-type fuzzy sets are becoming popular. However, in the area of electrical drives there are only limited works showing this approach.

The motivation of this study is to design an adaptive control system based on the MRAS theory for nonlinear two-mass system. In order to improve the quality of control of complex mechanical system an additional compensator is applied. The designed system should ensure good performance at different operation points including low speed region. The paper is organized as follows. After short introduction, a mathematical model of the plant is presented. Then, fuzzy structure is briefly described. The additional compensator is presented. Next the simulation and experimental results are demonstrated. Short conclusions are drawn at the end of the paper.

2. MATHEMATICAL MODEL OF THE PLANT

In classical design procedure for electrical drive the assumption of infinite stiffness of the shaft is accepted. This is fulfilled for many drive systems with short mechanical connection and limited dynamic. However, in the drives with long shaft such as rolling mill drives, conveyor drives, windmill generators or high performance drives such as robot-arm drives, servo-drives or hard-disc drives [6]–[8], the characteristics of mechanical part should be taken into consideration. The torsional vibrations influence the dynamic of the system in negative way. Firstly, the performance of the drive is reduced. The torsional vibrations can even cause the drive to fail. Also, the stability of the control structure can be affected.

One of the most popular mathematical models of the drive system with elastic connection is an inertia-free two-mass model. It is described by the following differential equations

$$\frac{d\omega_1}{dt} = \frac{1}{T_1}(m_e - m_s), \quad (1)$$

$$\frac{d\omega_2}{dt} = \frac{1}{T_2}(m_s - m_L), \quad (2)$$

$$\frac{dm_s}{dt} = \frac{1}{T_c}(\omega_1 - \omega_2) \quad (3)$$

where $T_1 = J_1\Omega_{0N}/M_{eN}$, $T_2 = J_2\Omega_{0N}/M_{eN}$ – mechanical time constant of the motor and the load machine, $T_c = M_{eN}/K_c\Omega_{0N}$ – stiffness time constant, ω_1 , ω_2 – motor and load speeds, J_1 , J_2 – moment of inertia of the motor and the load machine, respectively, m_e , m_s , m_L – electromagnetic, shaft and load torques, K_c – factor of elasticity of the connecting element, Ω_{0N} – nominal speed, M_{eN} – nominal torque.

A block diagram of the two-mass system is presented in Fig. 1.

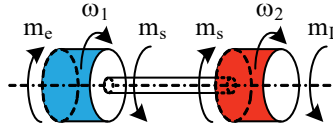

Fig. 1. Block diagram of two-mass system

The linear model of two-mass system can be applied in control structure of electrical drive with complicated mechanical part. However, if sophisticated control is required the more exact model of mechanical part should be implemented. The existing mechanical hysteresis can be modelled using the following equation [9]

$$m = a\Delta\varphi + b\Delta\varphi^3 + \tau(a + 3b\Delta\varphi^2)\frac{d\Delta\varphi}{dt} \quad (4)$$

where a , b – factors that determine the participation of linear and nonlinear elements of characteristics of the connecting element, τ – time constant of rising angle of twisting after step change of twisting torque, $\Delta\varphi = \varphi_1 - \varphi_2$ – angle of twisting of the connecting element.

The parameters of equation (4) can be identified by blocking the shaft on the load side and by changing the value of electromagnetic torque, which can designate the characteristics of a rod connecting the motors for established working range. In the case of industrial clutches, the manufacturers usually provide the characteristics of their products. During

the research there were assumed certain characteristics of applied clutch. The structure tested is an adaptive system, in which we assume volatility and ambiguity of parameters. The system should work properly also in the case of misidentification of parameters.

If operation range of electrical drive includes the low-speed region the mechanical friction should be considered. There are different models of friction, see survey in [10]–[12]. The most popular are the models based on constant characteristics. In the present work, the friction described by the following formula is used

$$m_{f_2}(\omega) = \text{sign}(\omega)(c|\omega| + d) \quad (5)$$

where c, d are the friction coefficients.

The identification has been performed on a disconnected shaft (no impact of clutch nonlinearity). A series of tests were performed, as a result of which a number of characteristics were obtained. These characteristics were approximated. The characteristics thus obtained were adopted during simulation tests. The proposed structure is an adaptive system, so it should work correctly also in a situation of misidentification of parameters.

A complete block diagram of nonlinear two-mass system is shown in Fig. 2.

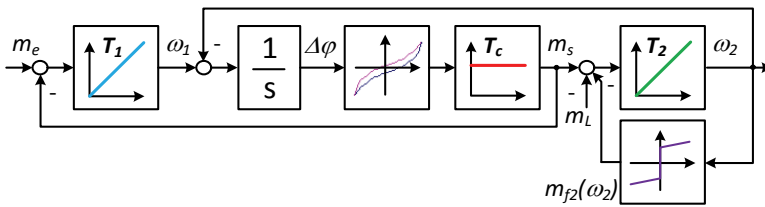

Fig. 2. Block diagram of nonlinear two-mass system

3. ADAPTIVE FUZZY CONTROL

The fuzzy logic controllers were proposed in the 1970's. It has the following parts: a fuzzifier, rules, an inference engine and defuzzifier. The classical fuzzy controller uses the type I membership function. However, the knowledge defined in the rule base is very often uncertain. It creates problems how to specify fuzzy information in sharp boundary of membership function. The uncertainty can have the following sources. Firstly, the words used in rules can have different meaning for different people. Secondly, the consequents specified by a group of experts can be different. And finally, the data can be disrupted by noises.

In recent years, the fuzzy controllers based on the II type of fuzzy sets become more and more popular. Despite the fact that those sets are more complicated, they possess several advantages. They can handle uncertain information and eliminate the aforementioned drawbacks of type I fuzzy sets.

In the paper, a fuzzy-neuro controller based on the II type sets is tested. The controller has a simple rule base with nine elements. The model reference adaptive control structure for on-line tuning fuzzy controller is proposed. A general diagram of the system is presented in Fig. 4.

The fuzzy controller is tuned so that the actual drive output can follow the output of the reference model. The tracking error is used as the tuning signal. The supervised gradient descent algorithm is used to tune the parameters of the neuro-fuzzy controller in the direction of minimizing the error between the model and plant output. Weights of the consequent layer are modified according to the following equation [13]

$$w_j(k+1) = w_j(k) + O_{N_j}^3(k_p e_m(k) + k_d \Delta e_m(k)) \tag{6}$$

where e_m – error between reference model response and actual speed of the drive system, k_p, k_d – parameters of the learning algorithm, $O_{N_j}^3$ – normalized firing strength of the j -th rule

The system characteristics depend on the parameters k_p and k_d of the learning algorithm.

As a reference mode the second order term is selected

$$G_m(s) = \frac{\omega_r^2}{s^2 + 2\xi_r \omega_r s + \omega_r^2} \tag{7}$$

where ξ_r – damping coefficient, ω_r – resonant frequency.

A simplified block diagram of adaptive fuzzy controller is presented in Fig. 3. It is clearly visible that the system has two inputs: error and change of error. Then in fuzzification layer the II-type fuzzy sets are used. At the end of the controller the reduction type block has to be placed as shown in Fig. 3. It translates the results obtained for the II-type sets to single value.

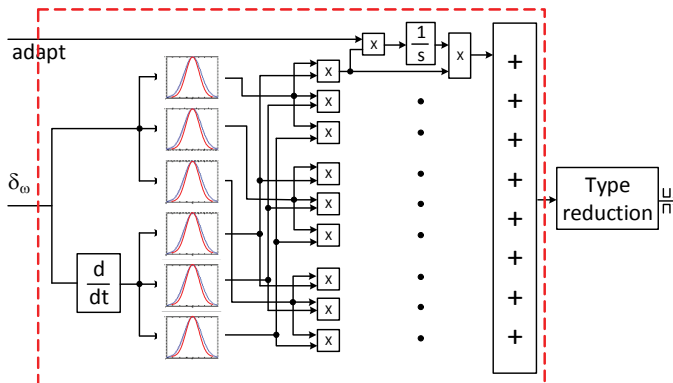

Fig. 3. Simplified block diagram of adaptive fuzzy controller

In order to improve performance of the adaptive control structure an additional compensator designed according to [14] is implemented. Its location in the adaptive control structure and particular elements are presented in Fig. 4. The proposed compensator should improve the quality of work of primary control structure. It has two main operation regions. When the control error is relatively small the compensator is not active. However, when the error is bigger than specified value this element is activated and is supporting the work of the main control structure.

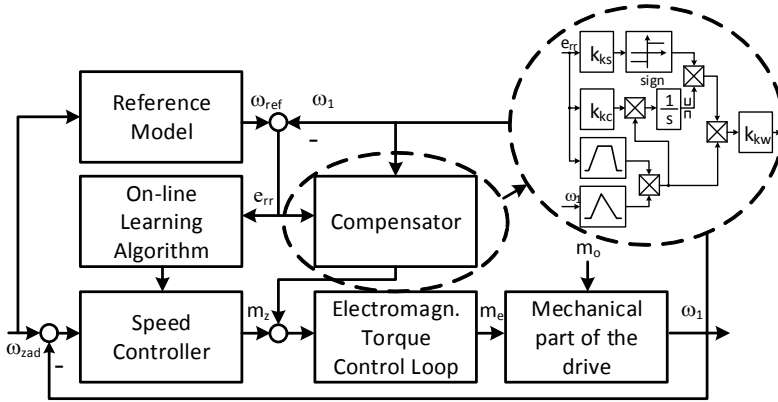

Fig. 4. Block diagram of adaptive control structure with fuzzy compensator

4. RESULTS OF RESEARCH

The proposed adaptive fuzzy controller is tested for the two-mass system with only one basic feedback from motor speed. Research was conducted for a wide range of speed. First, the proposed control algorithm is investigated for the drive system working for bigger speed reference value. The article presents the results of simulations for speed 0.5. For this value of speed the process of adaptation is shown. Transients of the system are presented in Figs. 5 and 6. In Fig. 5a, the model (blue), motor (red) and load (magenta) speeds are presented for 10 s of the system work. The system starts with the controller weights set to zeros. It means that the parameters of the drive are unknown. Despite this, the initial tracking error is small and is decreasing continually (Fig. 5b). In Fig. 6, fragments of the system speeds are shown. The difference between the model and load machine is bigger after 2.5 s than it is after 7.5 s of the work. After a short period of work the controller is almost tuned.

In Figs. 7–12, a comparison of classical PI controller with antiwindup and the proposed structure is presented. The structure presented is an extension of systems with

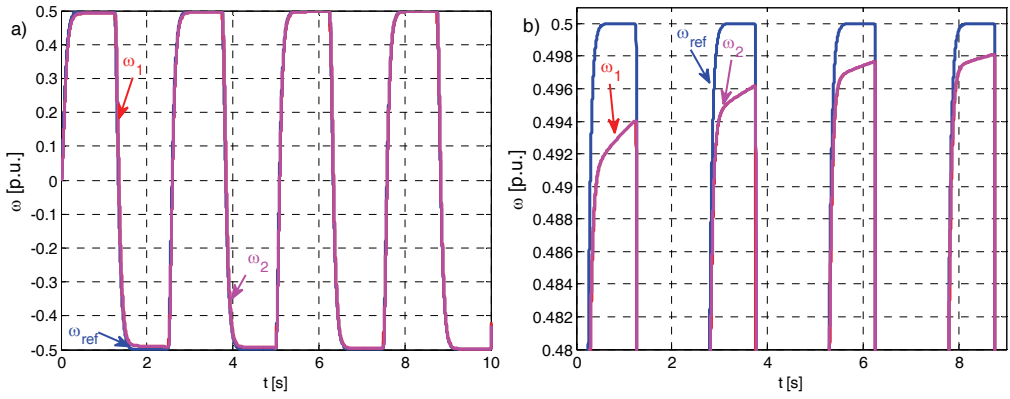

Fig. 5. Waveforms of the model (blue), motor (red) and load (magenta) speeds

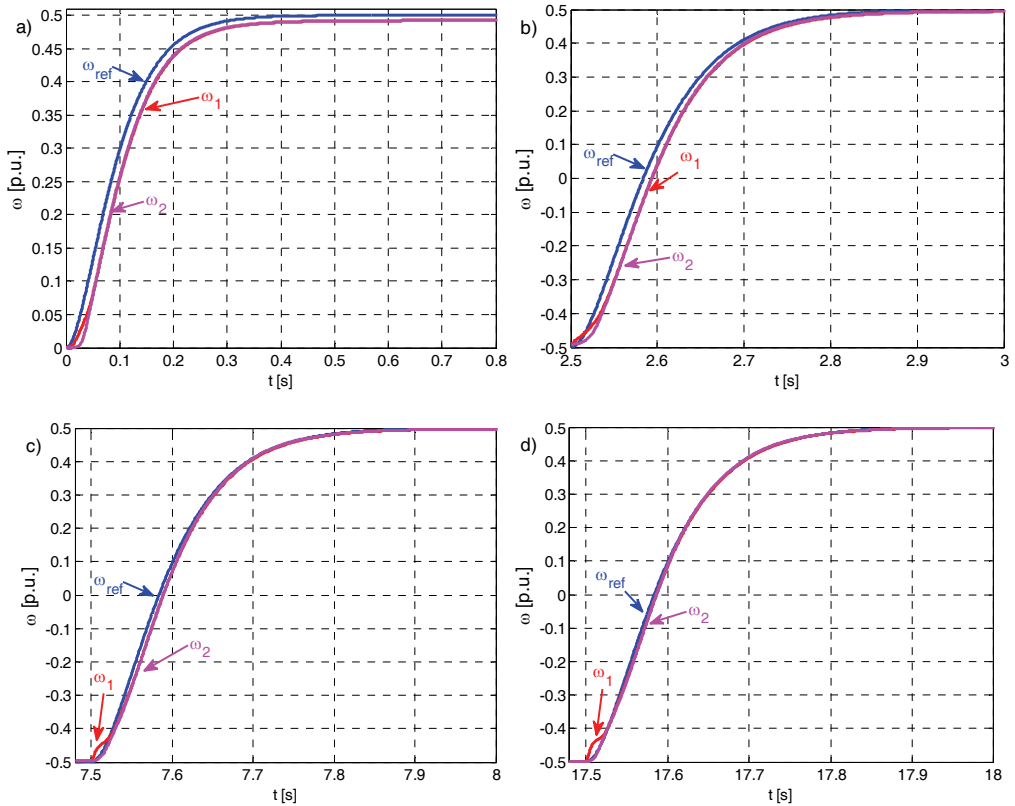

Fig. 6. Waveforms of speeds (model (blue), motor (red) and load (magenta)) in various periods of work

sets of type I. It has an additional compensator to compensate the friction. A comparison of systems with sets of type I and II without compensator has been presented in [15]. Parameters of classical PI controller (k_p, k_i) have been calculated by the genetic algorithm (the objective function has the form (8)). In each of the cases shown below, the fuzzy controller after adaptation works better than classical PI controller. The large errors of speed, in the case of classical PI controller, have been caused even through the small changes of the time constant of the load (Fig. 9). A clear difference is also seen in Figs. 11a and 12a.

$$y = k_1 k_2 + k_1 + k_2 \quad (8)$$

$$\text{where } k_1 = \frac{1}{L} \sum_{s=1}^L |\Omega^{\text{ref}} - \Omega_1|, \quad k_2 = \frac{1}{L} \sum_{s=1}^L |\Omega^{\text{ref}} - \Omega_2|.$$

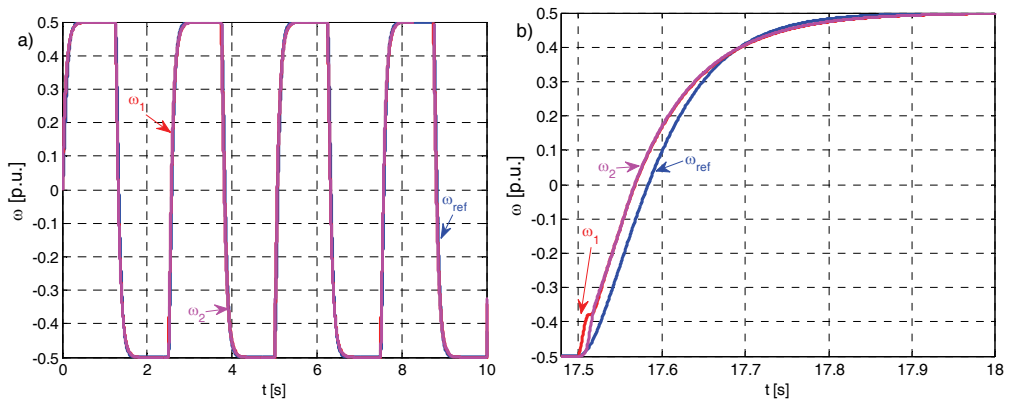

Fig. 7. Transients of speeds for classical PI controller with antiwindup ($T_2 = T_{2n} = 0.2$)

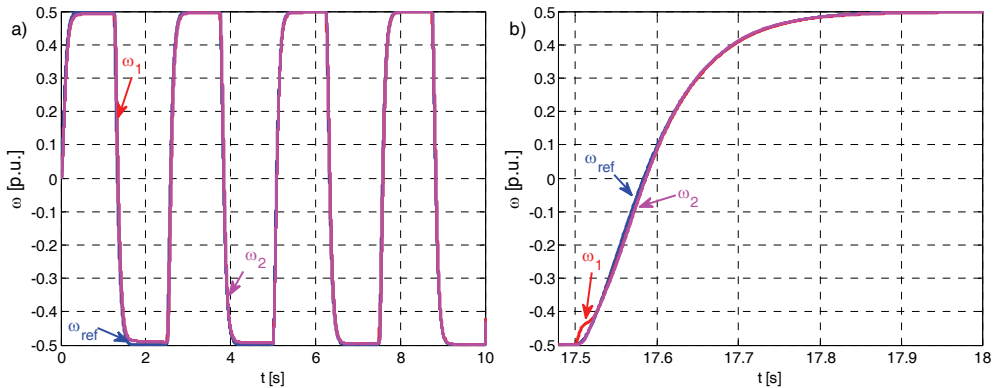

Fig. 8. Transients of speeds for fuzzy controller (with sets of type II) with additional compensator ($T_2 = T_{2n} = 0.2$)

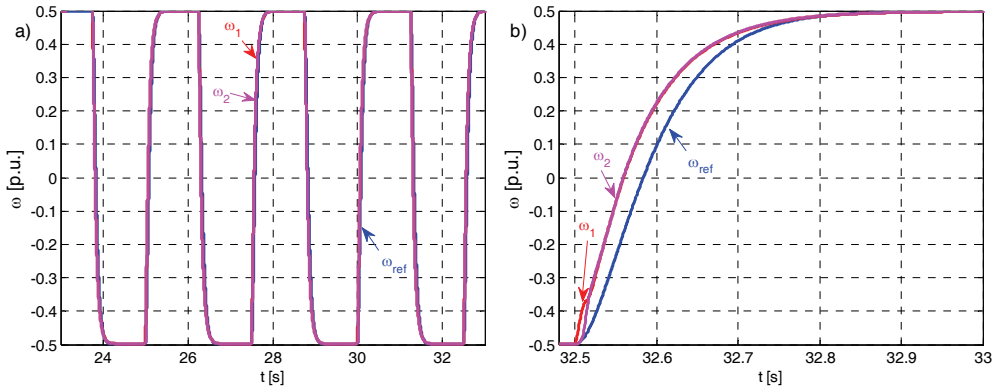

Fig. 9. Transients of speeds for classical PI controller with antiwindup ($T_2 = 0.15$)

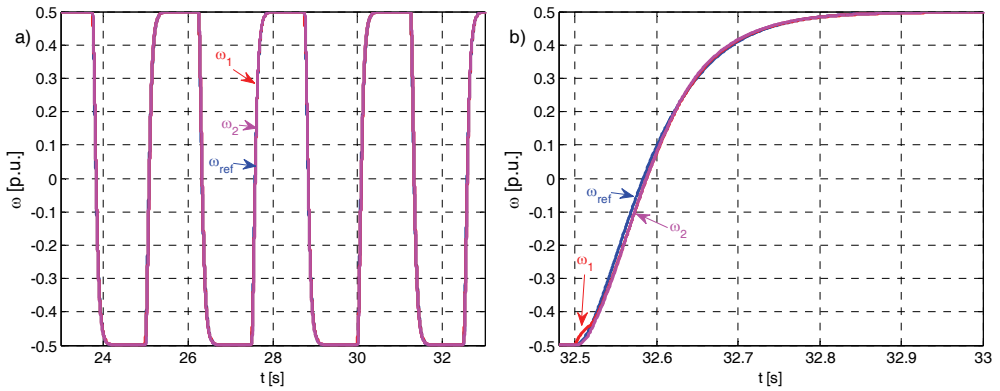

Fig. 10 Transients of speeds for fuzzy controller (with sets of type II) with additional compensator ($T_2 = 0.15$)

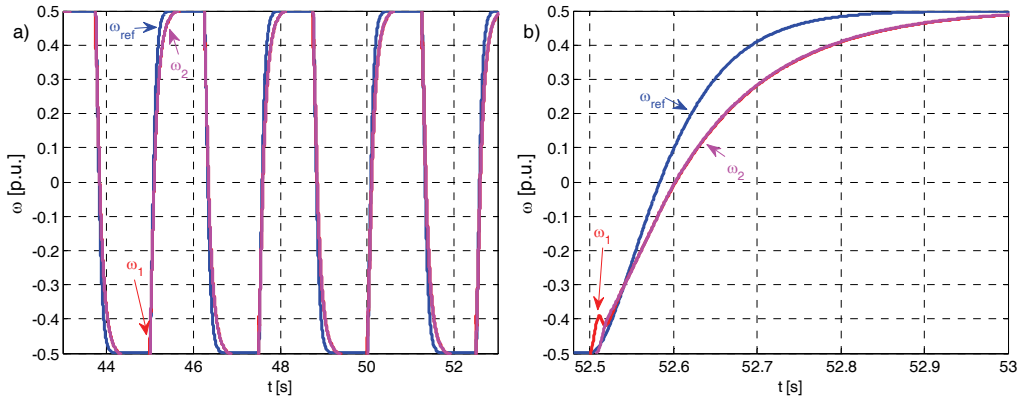

Fig. 11. Transients of speeds for classical PI controller with antiwindup ($T_2 = 0.4$)

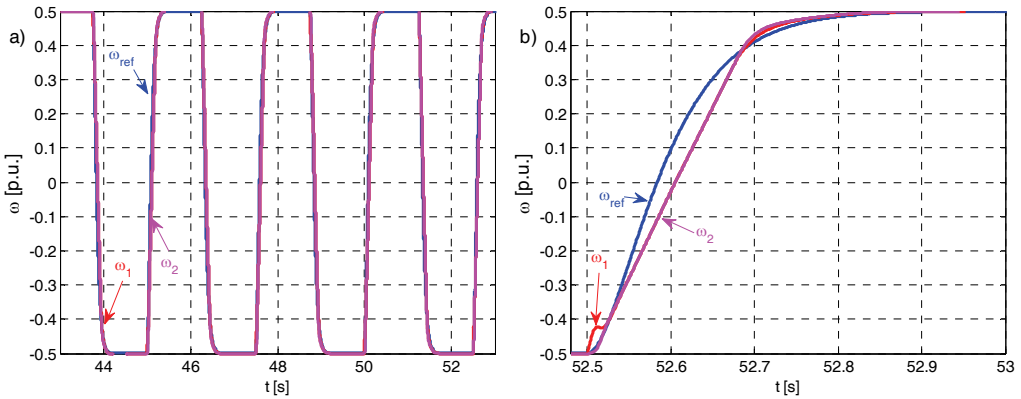

Fig. 12. Transients of speeds for fuzzy controller (with sets of type II) with additional compensator ($T_2 = 0.4$)

Then the system is tested for low speed region. As the low speed we recognize speed equal or less than 1% of rated speed. The experimental results are obtained for a speed of 0.01 [p.u.]. In the low-speed range there is clearly seen effect of the friction torque. The experimental setup is established to check the efficiency of the proposed controller in real conditions. This setup is composed of a DC motor driven by a four-quadrant chopper. The motor is coupled to a load machine by stiff and elastic shafts (a steel shaft of 6 mm in diameter and 600 mm in length). The load machine is also a DC motor. The two motors have the nominal power of 500 W each. The speed and position of both motors are measured by incremental encoders (Kubler) with a resolution of 36000 pulses per rotation. In addition, by measuring four edges the resolution increases four times. In the case of the elastic system, the mechanical system has a natural frequency close to 19 Hz. The control algorithm is implemented in the digital signal processor DS1103 using the dSPACE software. Research was conducted for reference speed values from 0.001 to 0.01. In the low-speed range there is clearly seen effect of the friction torque. In Fig. 13, selected transients of the system are presented. In Fig. 14, a comparison between system with and without compensator is presented. In the Figs. 14a and 14b the transients of motor and load speeds are presented, respectively. Speeds for the system with compensator are clearly closer to the model speed. In the Fig. 14c, the waveforms of errors between model and motor speed are shown. The errors obtained in structure with compensator are smaller by at least 10 percent. This is due to the fact that at the time of crossing the speed zero, the compensator causes that the reference torque (controller output) is greater than in the case of a system without a compensator (Fig. 14d). Increased torque reduces the impact of the moment of friction and non-linear characteristics of the coupling.

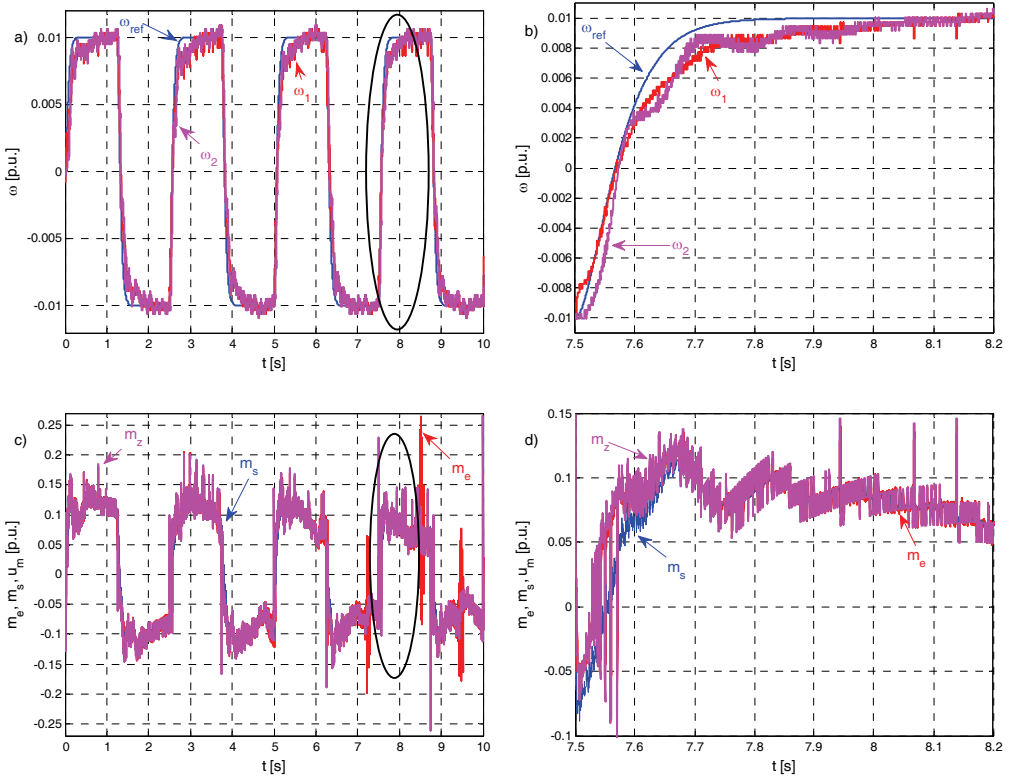

Fig. 13. Waveforms of the model, motor, load speeds (a), (b) and reference (m_z), shaft (m_s), electromagnetic (m_e) torques

The impact of the delay on the compensation of friction is a very important issue. This is influenced by many factors, including measuring systems, established dynamics of the system and the length of the delay. The impact of the delay will increase when the delay or the dynamics of the object is increased. In the system presented, no additional filter is used, introducing additional delays. Existing delays of the system result from the sampling period and in the absence of application of an additional filter have no significant effect on the results.

Figures 15 and 16 show the effect of the delay of speed measurement on control quality. In the case of a delay of one sampling period the system works correctly even during long simulation (Fig. 15). When the delay is 6 sampling periods in the simulation lasting 60 seconds, the system operates correctly (Fig. 16a). When the delay grows its influence also rises (Fig. 16b, 16c).

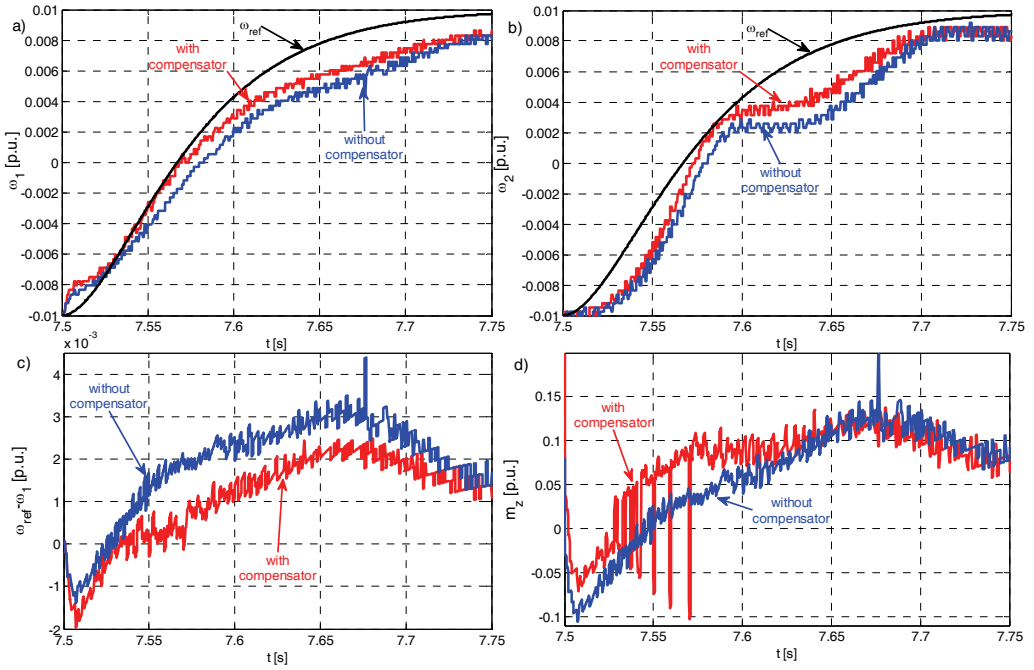

Fig. 14. Waveforms of motor speeds (a), load speeds (b), errors between reference and motor speed (c), reference torques (d) in system with and without compensator

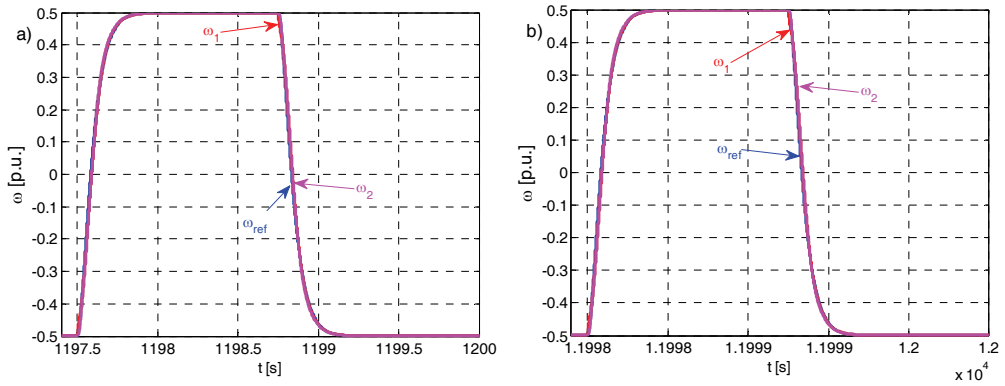

Fig. 15. Transients of speeds model (blue), motor (red) and load (magenta) for delay measurement of the speed (1 sampling period)

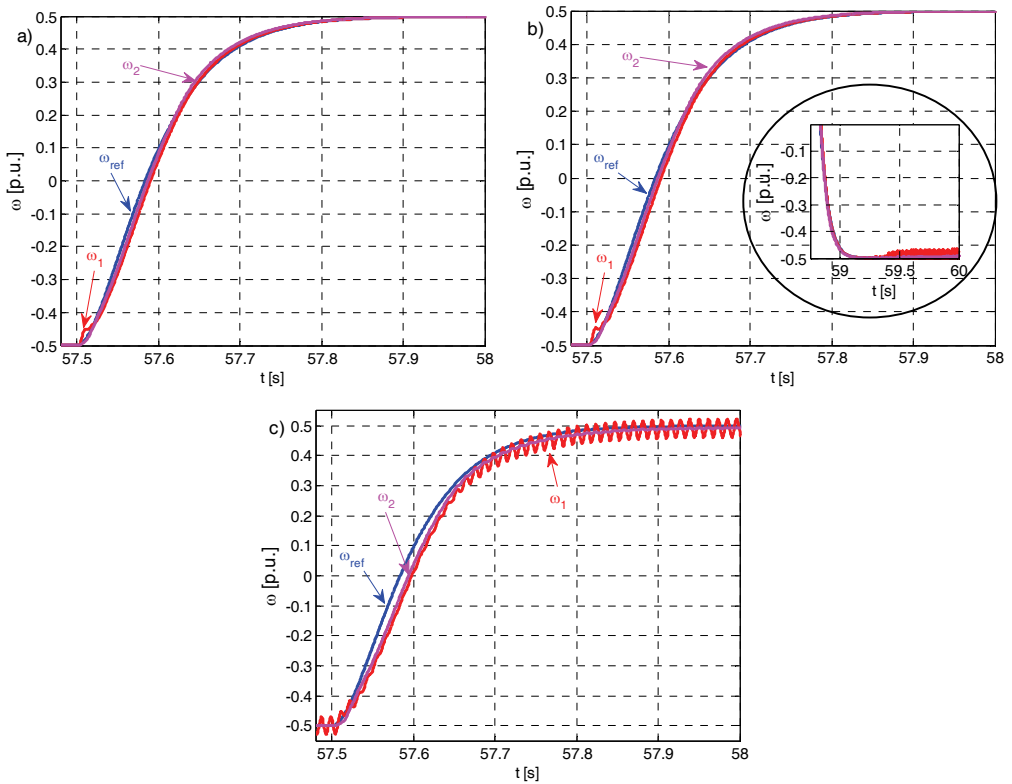

Fig. 16. Transients of speeds for delay measurement of the speed (6 (a), 7 (b) and 8 (c) sampling periods)

5. CONCLUSIONS

In this paper, the adaptive fuzzy controller of speed with compensator of friction and nonlinear characteristics of the coupling is presented. The proposed structure can work for big, low and ultra-low speed range and gives clearly better results than the classical PI controller. The process of adaptation runs correctly and quickly. The rate of adaptation can be increased by the appropriate correction of settings. However, at too high settings the system may become unstable. The influence of friction torque is best seen in the low speed range. The experimental studies confirm that compensator introduced to the structure improves operation of the fuzzy controller. The moment at which the influence of the friction torque is the greatest supports the action of the primary regulator by increasing the value of the required torque. This allows better control characteristics to be obtained. Existing delays of the system have no significant effect on the results.

REFERENCES

- [1] WAI R., LIN C.M., HSU C.F., *Adaptive fuzzy sliding-mode control for electrical servo drive*, Fuzzy Sets and Systems, 2004, 143, 2, 295–310.
- [2] PILTAN F., SULAIMAN N., ALLAHADADI S., DIALAME M., ZARE A., *Position Control of Robot Manipulator: Design a Novel SISO Adaptive Sliding Mode Fuzzy PD Fuzzy Sliding Mode Control*, Int. Journal of Artificial Intelligence and Expert System, 2011, 2, 5, 208–228.
- [3] KNYCHAS S., DERUGO P., SZABAT K., *Damping of the torsional vibration using adaptive fuzzy control system with different recurrences*, 2014 IEEE 23rd International Symposium on Industrial Electronics (ISIE), Istanbul, 2014, 1526–1531.
- [4] DERUGO P., KACERKA J., JASTRZĘBSKI M., SZABAT K., *Analiza ARN-R PID z warstwą tranzycji Petriego, w sterowaniu silnikiem liniowym z magnesami trwałymi*, Poznań University of Technology Academic Journals, 2015, 83, 2015, 31–38.
- [5] DERUGO P., KACERKA J., SZABAT K., *Adaptacyjny regulator neuronowo-rozmyty z rekurencjami i warstwą tranzycji Petriego w sterowaniu napędem elektrycznym*, Przegląd Elektrotechniczny, 2016, 92, 4, 79–84.
- [6] SZABAT K., ORŁOWSKA-KOWALSKA T., *Vibration Suppression in a Two-Mass Drive System Using PI Speed Controller and Additional Feedbacks – Comparative Study*, IEEE Trans. on Industrial Electronics, 2007, 54, 2, 1193–1206.
- [7] ORŁOWSKA-KOWALSKA T., DYBKOWSKI M., SZABAT K., *Adaptive Sliding-Mode Neuro-Fuzzy Control of the Two-Mass Induction Motor Drive Without Mechanical Sensors*, IEEE Transactions on Industrial Electronics, 2009, 57, 2, 553–564.
- [8] SERKIES P., SZABAT K., *Application of the MPC to the Position Control of the Two-Mass Drive System*, IEEE Transactions on Industrial Electronics, 2012, 60, 9, 3679–3688.
- [9] KAROLEWSKI B., *Modelowanie więzów łączących elementy układu napędowego*, Przegląd Elektrotechniczny, 2001, 77, 2, 39–43.
- [10] OLSSON H., ASTROM K.J., CANUDAS de WIT C., GAFVERT M., LISCHINSKY P., *Friction Models and Friction Compensation*, European Journal of Control, 1998, 4, 3, 176–195.
- [11] CILIZ M.K., TOMIZUKA M., *Friction modeling and compensation for motion control using hybrid neural network models*, Engineering Application of AI, 2007, 20, 7, 898–911.
- [12] BONA B., INDRI, M., *Friction Compensation in Robotics: an Overview*, IEEE Conference on Decision and Control, 2005, 4360–4367.
- [13] LIN F.J., FUNG R.F., WAI R.J., *Comparison of sliding-mode and fuzzy neural network control for motor-toggle servomechanism*, IEEE Trans. Mechatronics, 1998, 3, 4, 302–318.
- [14] SZABAT K., KAMIŃSKI M., ORŁOWSKA-KOWALSKA T., *Robust Control of an Electrical Drive using Adaptive Fuzzy Logic Control Structure with Sliding-Mode Compensator*, The International Conference on “Computer as a Tool” EUROCON, 2007, Warsaw, 1706–1711.
- [15] WRÓBEL K., *Adaptive fuzzy control based on sets of the second type of the complex drive system operating at low speed*, Scientific Papers of the Institute of Electrical Machines, Drives and Measurements of the Wrocław University of Technology, Studies and Research, 2015, 71, 35, 109–117.